

Glass Passivated Rectifier Diode Modules



VRRM 800 to 1800V
IFAV 36 A

Applications

- Non-controllable rectifiers for AC/AC converters
- Line rectifiers for transistorized AC motor controllers
- Field supply for DC motors

Features

- Blocking voltage: 800 to 1800V
- Heat transfer through aluminum oxide DBC ceramic isolated metal baseplate
- Glass passivated chip
- UL recognized applied for file no. E360040

Circuit

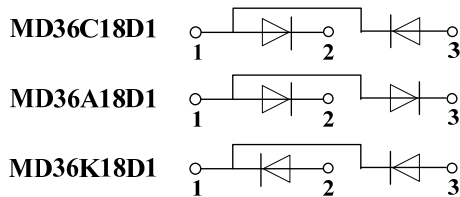

Module Type

TYPE			VRRM	VRSM
MD36C08D1	MD36A08D1	MD36K08D1	800V	900V
MD36C12D1	MD36A12D1	MD36K12D1	1200V	1300V
MD36C16D1	MD36A16D1	MD36K16D1	1600V	1700V
MD36C18D1	MD36A18D1	MD36K18D1	1800V	1900V

Maximum Ratings

Symbol	Conditions	Values	Units
I_{FAV}	Single phase ,half wave 180° conduction $T_c=104^{\circ}C$	36	A
I_{FSM}	$t=10mS$ $T_{vj}=45^{\circ}C$	650	A
i^2t	$t=10mS$ $T_{vj}=45^{\circ}C$	2100	A^2s
V_{isol}	a.c.50HZ;r.m.s.;1min	3000	V
T_{vj}		-40 to +150	$^{\circ}C$
T_{stg}		-40 to +125	$^{\circ}C$
M_t	To terminals(M5)	$3\pm 15\%$	Nm
M_s	To heatsink(M6)	$5\pm 15\%$	Nm
Weight	Module (Approximately)	100	g

Thermal Characteristics

Symbol	Conditions	Values	Units
$R_{th(j-c)}$	Per diode	0.6	$^{\circ}C/W$
$R_{th(j-c)}$	Per Module	0.3	$^{\circ}C/W$
$R_{th(c-s)}$	Module	0.1	$^{\circ}C/W$

Electrical Characteristics

Symbol	Conditions	Values			Units
		Min.	Typ.	Max.	
V_{FM}	$T=25^{\circ}C$ $I_F=75A$	—	1.0	1.18	V
V_{FM}	$T=25^{\circ}C$ $I_F=100A$	—	1.25	1.40	V
I_{RD}	$T_{vj}=150^{\circ}C$ $V_{RD}=V_{RRM}$	—	—	5	mA



Performance Curves

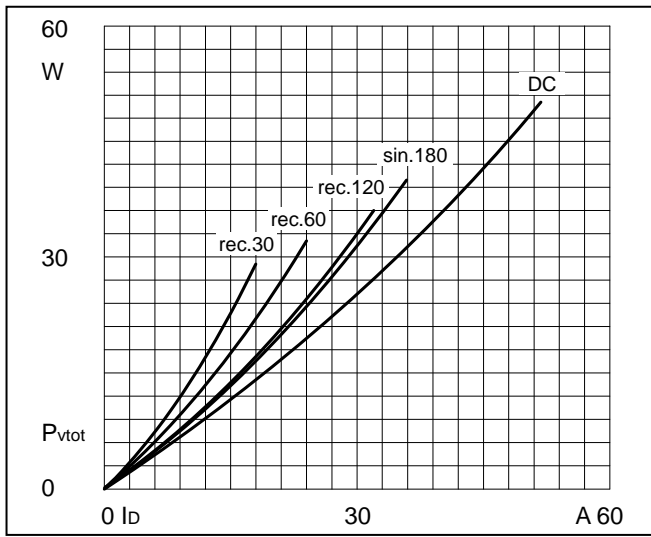

Fig1. Power dissipation

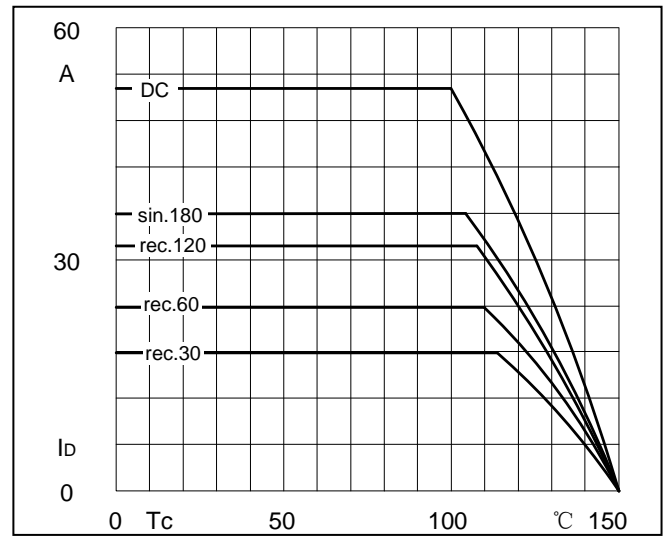

Fig2. Forward Current Derating Curve

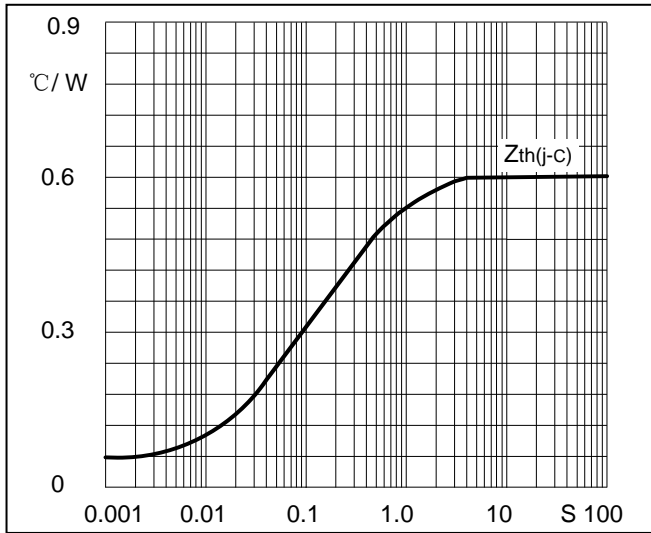

Fig3. Transient thermal impedance

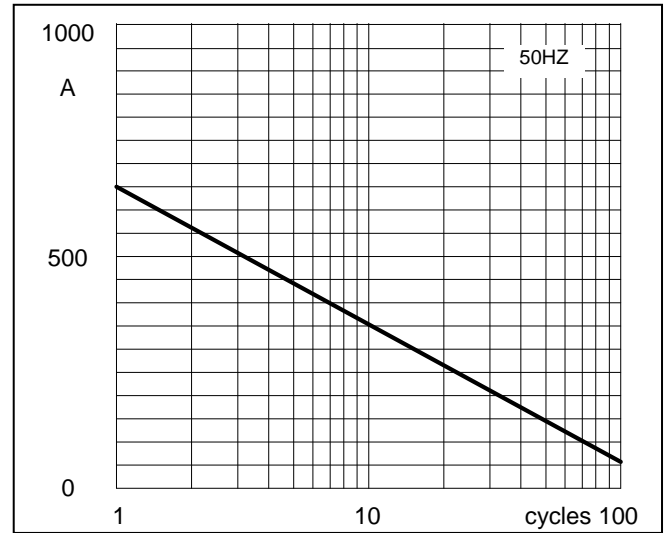

Fig4. Max Non-Repetitive Forward Surge Current

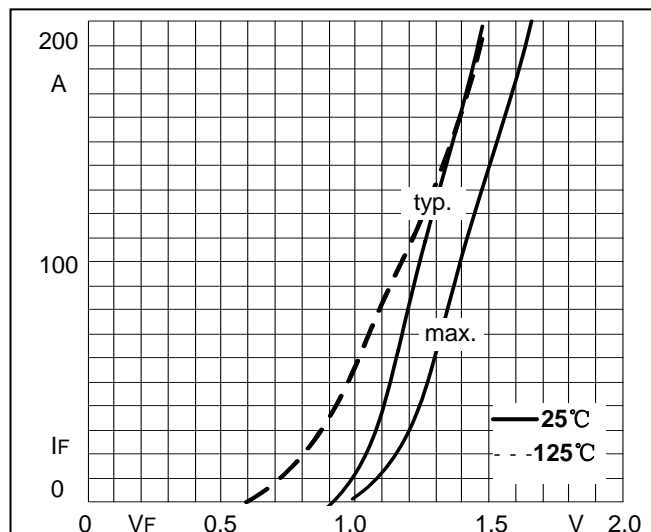
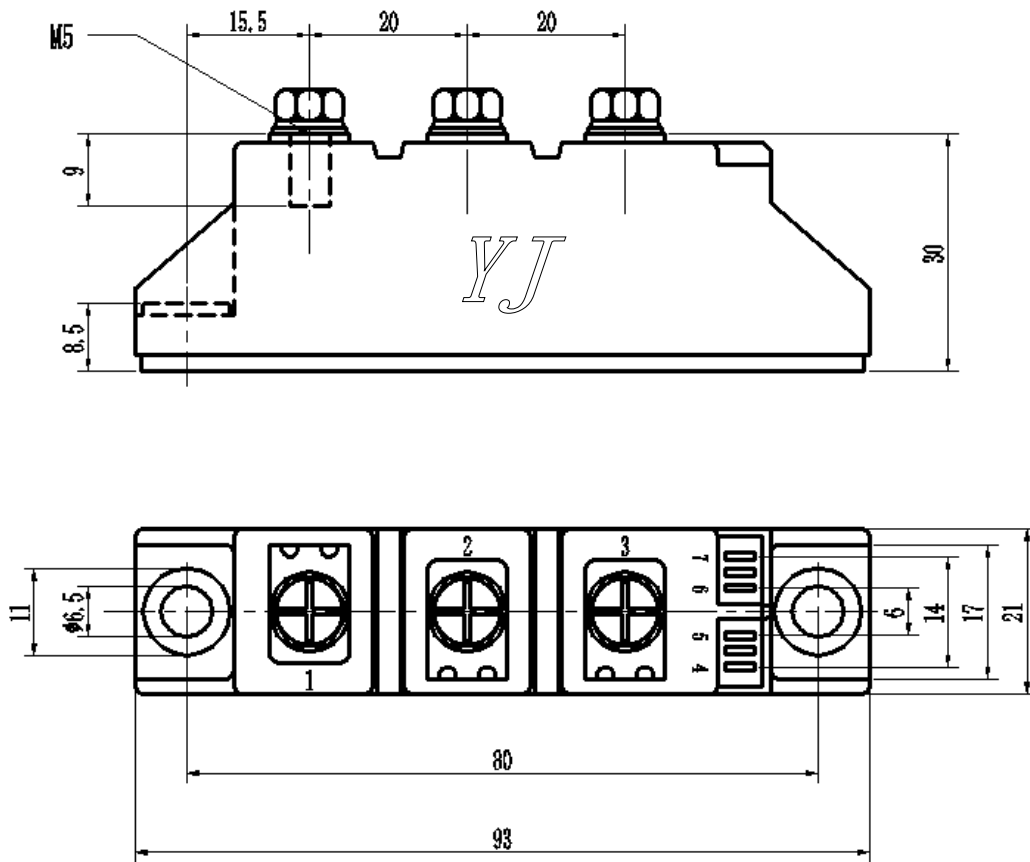

Fig5. Forward Characteristics

Package Outline Information

CASE: D1



Dimensions in mm